

Fresh Water Controller FWC3

Installation and operating instructions

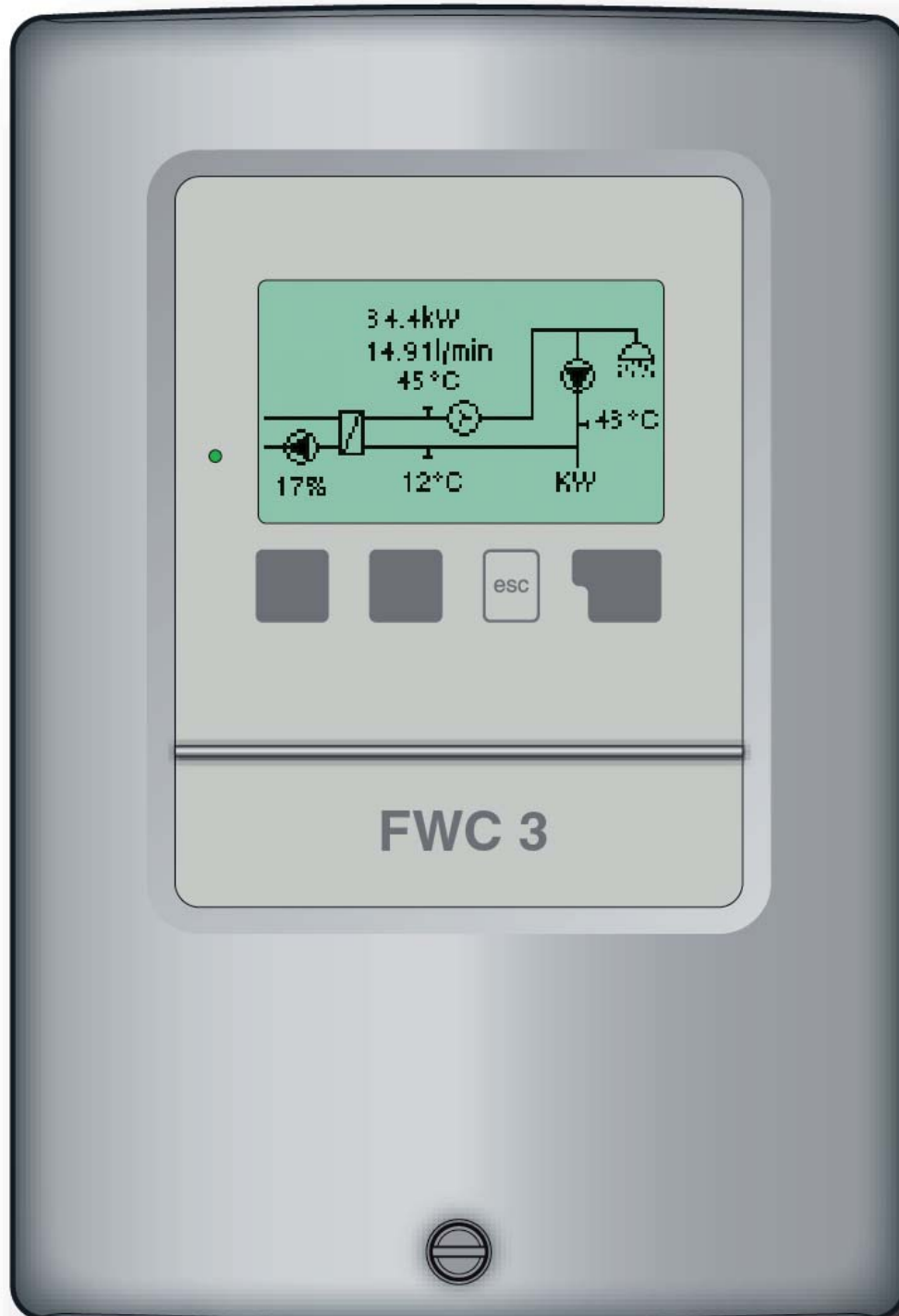

Read carefully before installation, commissioning and operation

Contents

<p>1 Safety instructions</p> <p>1.1 EC conformity 3</p> <p>1.2 General instructions 3</p> <p>1.3 Explanation of symbols 3</p> <p>1.4 Changes 4</p> <p>1.5 Warranty 4</p> <p>2 Description of controller</p> <p>2.1 Specifications 5</p> <p>2.2 About the controller 6</p> <p>2.3 Scope of supply 6</p> <p>2.4 Disposal of pollutants 6</p> <p>2.5 Hydraulic variants 7</p> <p>3 Installation</p> <p>3.1 Electrical connection 8-11</p> <p>4 Operation</p> <p>4.1 Display and input 12</p> <p>4.2 Menu sequence 13</p> <p>5 Parametrisation</p> <p>5.1 Commissioning help 14</p> <p>5.2 Free commissioning 14</p> <p>6 Measurement menu 1 values 15</p> <p>7 Analyses menu 2</p> <p>7.1 Operating hours HW 16</p> <p>7.2 Operating hours circ. 16</p> <p>7.3 Heat output 16</p> <p>7.4 Graphic overview 16</p> <p>7.5 Error messages 16</p> <p>7.6 Reset/clear 16</p> <p>8 Display mode menu 3</p> <p>8.1 Schematic 17</p> <p>8.2 Overview 17</p> <p>8.3 Alternating 17</p>	<p>9 Operating modes menu 4</p> <p>9.1 Automatic 18</p> <p>9.2 Manual 18</p> <p>9.3 Off 18</p> <p>10 Settings menu 5</p> <p>10.1-10.3 Tsetpoint, Tmax, ... 19</p> <p>10.4-10.7 Circ. request 20</p> <p>10.8-10.10 Circ. periods 21</p> <p>11 Special functions menu 6</p> <p>11.1 Time & date 22</p> <p>11.2 Sensor calibration 22</p> <p>11.3 Commissioning 22</p> <p>11.4 Factory settings 22</p> <p>11.5 Anti legionella 23</p> <p>11.6 Expansions 24</p> <p>11.7 Speed control 24</p> <p>11.8 Lime scale protection 24</p> <p>12 Menu lock menu 7 25</p> <p>13 Language menu 9 25</p> <p>14 Service values menu 8 26</p> <p>15 Malfunctions/maintenance</p> <p>15.1 Error messages 27</p> <p>15.2 Replacing the fuse 28</p> <p>15.3 Maintenance 28</p>
--	---

1.1 EC declaration of conformity

By affixing the CE mark to the unit the manufacturer declares that the FWC3 conforms to the following relevant safety regulations:

- EC low voltage directive
73/23/EEC, as amended by 93/68/EEC
- EC electromagnetic compatibility directive
89/336/EEC version 92/31/EEC version 93/68/EEC

Conformity has been verified and the corresponding documentation and the EC declaration of conformity are kept on file by the manufacturer.

1.2 General instructions **It is essential that you read this!**

These installation and operating instructions contain basic instructions and important information regarding safety, installation, commissioning, maintenance and the optimal use of the unit. Therefore these instructions must be read completely and understood by the installation technician/specialist and by the system user before installation, commissioning and operation of the unit. The valid accident prevention regulations, VDE regulations, the regulations of the local power utility, the applicable DIN-EN standards and the installation and operating instruction of the additional system components must also be observed. The controller does not under any circumstances replace any safety devices to be provided by the customer!

Installation, electrical connection, commissioning and maintenance of the unit may only be carried out by specialists who possess the appropriate training.

For the user: Make sure that the specialist gives you detailed information on the function and operation of the controller. Always keep these instructions in the vicinity of the controller.

1.3 Explanation of symbols



Danger

Failure to observe these instructions can result in danger to life from electric voltage.



Danger

Failure to observe these instructions can result in serious damage to health such as scalding, or even life-threatening injuries.



Caution

Failure to observe these instructions can result in destruction of the unit or the system, or damage to the environment.



Caution

Information which is especially important for the function and optimal use of the unit and the system.

1.4 Changes to the unit



Danger

Changes to the unit can compromise the safety and function of the unit or the entire system.

- Changes, additions to or conversion of the unit are not permitted without the written permission from the manufacturer
- It is likewise forbidden to install additional components that have not been tested together with the unit
- If it becomes clear that safe operation of the unit is no longer possible, for example because of damage to the housing, then turn the controller off immediately
- Any parts of the unit or accessories that are not in perfect condition must be exchanged immediately
- Use only original spare parts and accessories from the manufacturer.
- Markings made on the unit at the factory must not be altered, removed or made illegible
- Only the settings actually described in these instructions may be made on the controller

1.5 Warranty and liability

The controller has been manufactured and tested with regard to high quality and safety requirements. The unit is subject to the statutory guarantee period of two years from the date of sale.

The warranty and liability shall not include, however, any injury to persons or material damage that is attributable to one or more of the following causes:

- Failure to observe these installation and operating instructions
- Improper installation, commissioning, maintenance and operation
- Improperly executed repairs
- Unauthorised structural changes to the unit
- Installation of additional components that have not been tested together with the unit
- Any damage resulting from continued use of the unit despite an obvious defect
- Failure to use original spare parts and accessories
- Use of the device for other than its intended purpose
- Operation above or below the limit values listed in the specifications
- Force majeure

2.1 Specifications

Electrical specifications:

Mains voltage	230VAC +/- 10%
Mains frequency	50...60Hz
Power consumption	2VA
Switched power	
Electronic relay R1	min.20W...max.120W for AC3
Mechanical relay R2	460VA for AC1 / 185W for AC3
Internal fuse	2A slow blow 250V
Protection category	IP40
Protection class	II
Sensor inputs	3 x Pt1000 + 1x Vortex Flow Sensor (VFS)

Permissible ambient conditions:

Ambient temperature	
for controller operation	0°C...40°C
for transport/storage	0°C...60°C
Air humidity	
for controller operation	max. 85% rel. humidity at 25°C
for transport/storage	no moisture condensation permitted

Other specifications and dimensions

Housing design	2-part, ABS plastic
Installation methods	Wall installation, optionally panel installation
Overall dimensions	163mm x 110mm x 52mm
Aperture installation dimensions	157mm x 106mm x 31mm
Display	Fully graphical display 128 x 64 dots
Light diode	Multicolour
Operation	4 entry keys

Temperature sensors: (may not be included in the scope of supply)

immersion sensor	Pt1000, e.g. TT/P4 up to 95°C
pipe-mounted sensor	Pt1000, e.g. TR/P4 up to 95°C
Vortex Flow Sensor	flow and temperature measuring
Sensor leads	2x0.75mm ² extendable to max. 30m

Temperature resistance table for Pt1000 sensors

°C	0	10	20	30	40	50	60	70	80	90	100
Ω	1000	1039	1077	1116	1155	1194	1232	1270	1308	1347	1385

2.2 About the controller

The Fresh water controller FWC3 facilitates efficient use and function control of your fresh water system. The device is impressive most of all for its functionality and simple, almost self-explanatory operation. For each step in the input process the individual entry keys are assigned to appropriate functions and explained. The controller menu contains headwords for the measured values and settings, as well as help texts or clearly-structured graphics.

Important characteristics of the FWC3:

- Depiction of graphics and texts in a lighted display
- Simple viewing of the current measurement values
- Analysis and monitoring of the system by means of statistical graphics, etc.
- Extensive setting menus with explanations
- Menu block can be activated to prevent unintentional setting changes
- Resetting to previously selected values or factory settings

2.3 Scope of supply:

- Fresh water controller FWC3
- replacement fuse 2A slow-blow
- Installation and operating instructions FWC3

Optionally contained depending on design/order:

- Pt1000 temperature sensor and Vortex Flow Sensor (TFS)

2.4 Disposal and pollutants

The unit conforms to the European RoHS directive 2002/95/EC for the restriction of the use of certain hazardous substances in electrical and electronic equipment.



Caution

The unit must not under any circumstances be disposed of with ordinary household refuse. Dispose of the unit only at appropriate collection points or ship it back to the seller or manufacturer.

2.5 Hydraulic variants



Caution

The following illustrations should be viewed only as schematic diagrams showing the respective hydraulic systems, and do not claim to be complete. The controller does not replace safety devices under any circumstances. Depending on the specific application, additional system components and safety components may be mandatory, such as check valves, non-return valves, safety temperature limiters, scalding protectors, etc., and must therefore be provided.

①

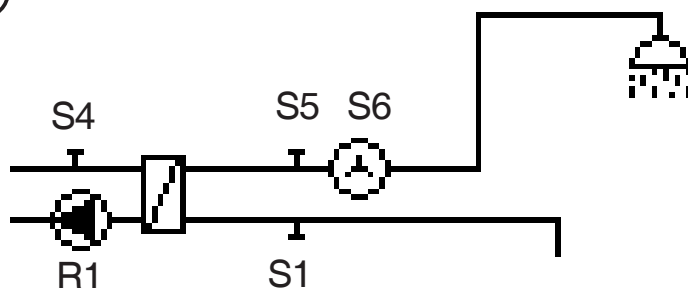

②

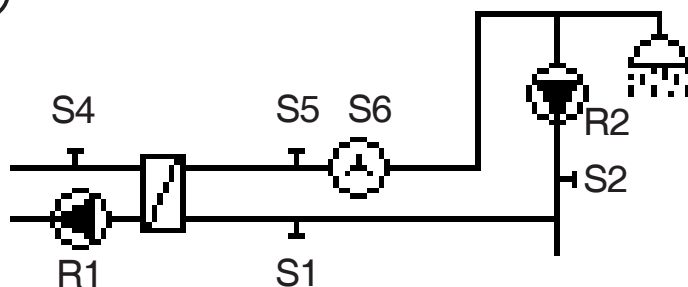

Caution

For optimal function of the system, it is necessary to have a constant temperature of at least 60 °C in the primary circuit while it is active. This temperature is measured at sensor 4.



Caution

If the water is very calcareous and the temperature of flow could be very high (over 70 °C), for not creating limescale in the secondary side of exchanger, we suggest a thermostatic valve in the primary circuit to reduce the temperature to normal values.

3.1 Wall installation



Caution

Install the controller only in dry areas and under the ambient conditions described under 2.1 “Specifications”. Carry out the following steps 1-8.

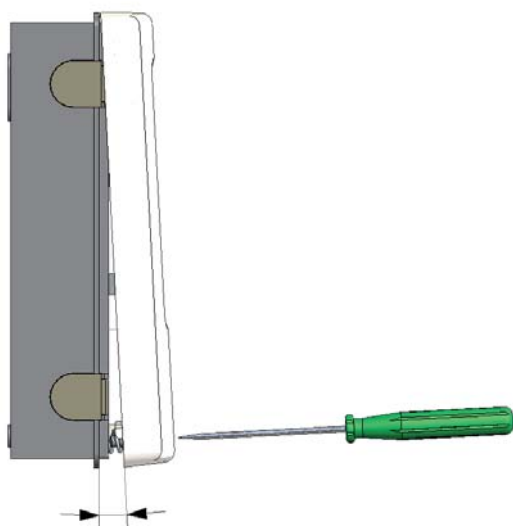

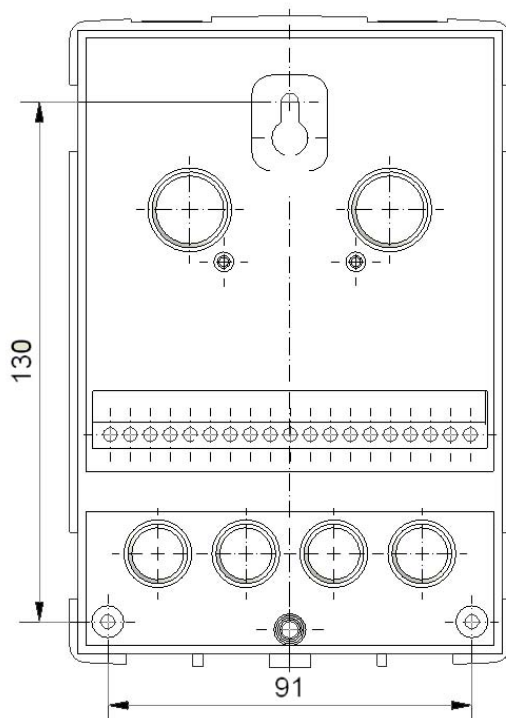

Fig.3.1.1

1. Unscrew cover screw completely
2. Carefully pull upper part of housing from lower part.
3. Set upper part of housing aside, being sure not to touch the electronics when doing so.
4. Hold the lower part of the housing up to the selected position and mark the 3 mounting holes. Make sure that the wall surface is as even as possible so that the housing does not become distorted when it is screwed on.

Fig.3.1.2

-  3x 4,0 x 40
-  3x Ø6



5. Using a drill and size 6 bit, drill 3 holes at the points marked on the wall and push in the plugs.
6. Insert the upper screw and screw it in slightly.
7. Fit the upper part of the housing and insert the other two screws.
8. Align the housing and tighten the three screws.

3.1 Electrical connection



Before working on the unit, switch off the power supply and secure it against being switched on again! Check for the absence of power! Electrical connections may only be made by a specialist and in compliance with the applicable regulations. Do not use the controller if the housing shows visible damage.



Low-voltage cables such as temperature sensor cables must be routed separately from mains voltage cables. Feed temperature sensor cables only into the left-hand side of the unit, and mains voltage cables only into the right-hand side.



The customer must provide an all-pole disconnecting device, e.g. a heating emergency switch.



The cables being connected to the unit must not be stripped by more than 55mm, and the cable jacket must reach into the housing just to the other side of the strain relief.



Relay R1 is only suitable for standard pumps (20-120VA) which are speed-controlled via the controller. The internal wiring of the controller is such that residual currents flow over relay R1 even in the rest condition. Therefore under no circumstances may valves, contactors or other consumers with low power consumption be operated on this output.

Fig.3.2.1

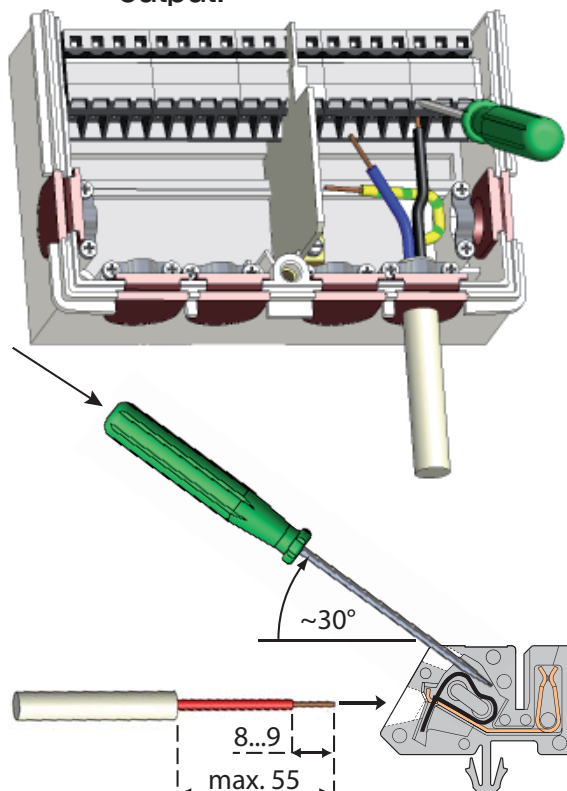

3.1 Electrical connection

1. Select necessary program/ hydraulics (Fig. 3.2.2-3.2.3)
2. Open controller
3. Strip cables by 55mm max., insert, fit the strain relief devices, strip the last 8-9mm of the wires. (Fig. 3.2.1)
4. Open the terminals using a suitable screwdriver (Fig. 3.2.1) and make electrical connections on the controller (Pages 10-11)
5. Refit upper part of housing and fasten with screw.
6. Switch on mains voltage and place controller in operation.

3.2 Electrical connection (continued)

Fig. 3.2.2 „Without circulation pump“

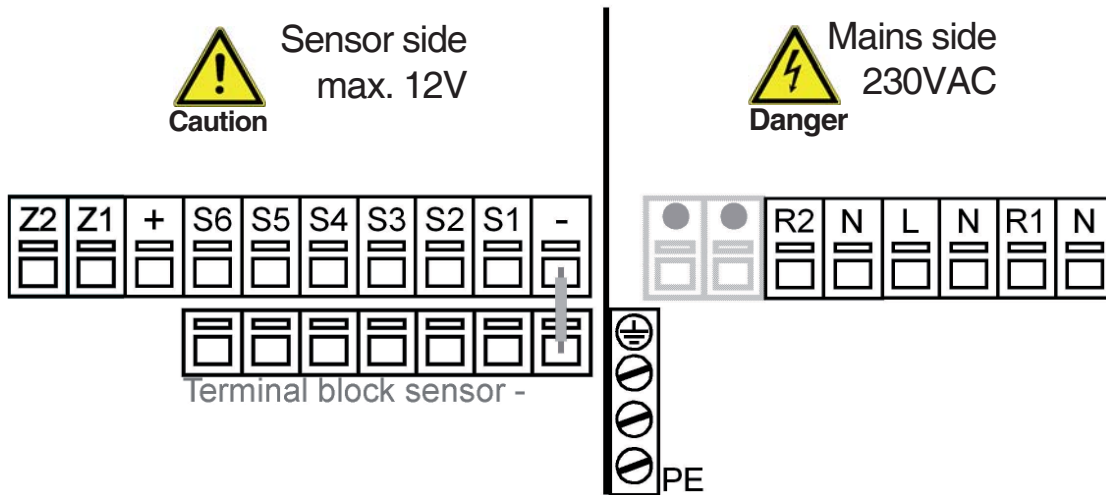

Low voltage max. 12VAC/DC
connection in the left-hand terminal
compartment!

Terminal:	Connection for:
S1	PT1000 cold water
S2	Not used
S3	PT1000 stor.tank opt.
S4	PT1000 flow primary
S5	Hot water (VFS yellow)
S6	Flow (VFS white)
+	VFS brown (+)
-	VFS green (-)

The polarity of the sensors is freely
selectable.

Connection of sensor earths via
terminal block sensor (-)

Mains voltages 230VAC 50-60Hz
Connection in the right-hand terminal
compartment!

Terminal:	Connection for:
L	Mains phase conductor L
N	Mains neutral conductor N
R1	Fresh water pump L
N	Fresh water pump N
R2	Not used
N	Not used

The PE protective conductor must be
connected to the PE metal terminal
block!



Caution

Relais R1: Only for speed
control of standard pumps,
minimum load 20 VA

Fig. 3.2.3 „With circulation pump“

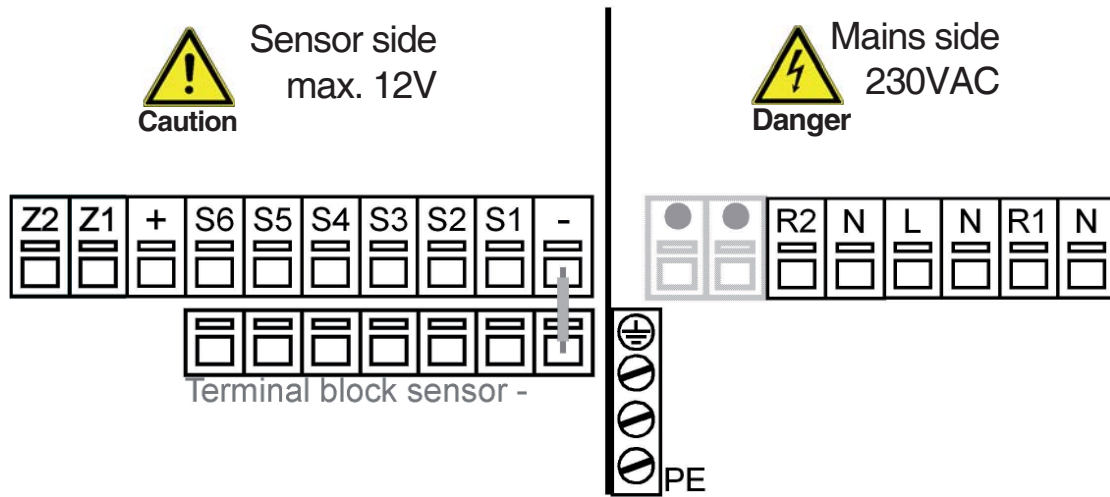

Low voltage max. 12VAC/DC connection in the left-hand terminal compartment!

Terminal:	Connection for:
S1	PT1000 cold water
S2	PT 1000 circulation
S3	PT1000 stor.tank opt.
S4	PT1000 flow primary
S5	Hot water (VFS yellow)
S6	Flow (VFS white)
+	VFS brown (+)
-	VFS green(-)

The polarity of the sensors is freely selectable.

Connection of sensor earths via terminal block sensor(-)

Mains voltages 230VAC 50-60Hz Connection in the right-hand terminal compartment!

Terminal:	Connection for:
L	Mains phase conductor L
N	Mains neutral conductor N
R1	Fresh water pump L
N	Fresh water pump N
R2	Circulation pump L
N	Circulation pump N

The PE protective conductor must be connected to the PE metal terminal block!



Caution Relais R1: Only for speed control of standard pumps, minimum load 20 VA

4.1 Display and input

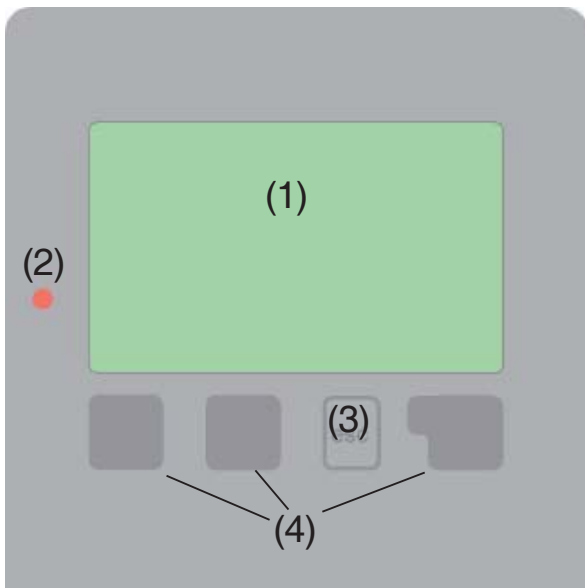

The display (1), with its extensive text and graphics mode, is almost self-explanatory, allowing easy operation of the controller.







The LED (2) lights up green when a relay is switched on.

The LED (2) lights up red when operating mode “Off” is set.

The LED (2) flashes slowly red in the operating mode “Manual”.

The LED (2) flashes quickly red when an error is present.

Examples of display symbols:

	Pump (rotates in operation)
	Flow meter
	heat exchanger
	Temperature sensor
	Warning/error message
	New information available

Entries are made using four keys (3+4), which are assigned to different functions depending on the situation. The “esc” key (3) is used to cancel an entry or to exit a menu. If applicable there will be a request for confirmation as to whether the changes which have been made should be saved. The function of each of the other three keys (4) is shown in the display line directly above the keys; the right-hand key is generally has a confirmation and selection function.

Examples of key functions:

+/-	= enlarge/shrink values
▼/▲	= scroll menu down/up
yes/no	= approve/reject
Info	= additional information
Back	= to previous screen
ok	= confirm selection
Confirm	= confirm setting

4.2 Menu sequence and menu structure

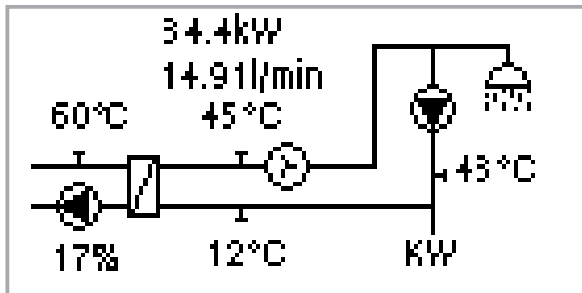

The graphics or overview mode appears when no key has been pressed for 2 minutes, or when the main menu is exited by pressing “esc”.



Pressing a key in graphics or overview mode takes you directly to the main menu. The following menu items are then available for selection there:



1. Measurement Values

Current temperature values with explanations (see 6.)

2. Statistics

Function control of the system with operating hours, etc. (see 7.)

3. Display mode

Select graphics mode or overview mode (see 8.)

4. Operating mode

Automatic mode, manual mode or switch unit off (see 9.)

5. Settings

Set parameters needed for normal operation (see 10.)

6. Special functions

Program selection, clock, etc. (see 11.)

7. Menu block

Against unintentional setting changes at critical points (see 12.)

8. Service Values

For diagnosis in the event of an error (see 13.)

5.1 Commissioning help



The first time the controller is turned on and after the language and time are set, a query appears as to whether you want to parametrise the controller using the commissioning help or not. The commissioning help can also be terminated or called up again at any time in the special functions menu. The commissioning help guides you through the necessary basic settings

in the correct order, and provides brief descriptions of each parameter in the display. Pressing the “esc” key takes you back to the previous value so you can look at the selected setting again or adjust it if desired. Pressing the “esc” more than once takes you back step by step to the selection mode, thus cancelling the commissioning help. Finally, menu 4.2 under operating mode “Manual” should be used to test the switch outputs with the consumers connected, and to check the sensor values for plausibility. Then switch on automatic mode.



Caution

Observe the explanations for the the individual parameters on the following pages, and check whether further settings are necessary for your application.

5.2 Free commissioning

If you decide not to use the commissioning help, you should make the necessary settings in the following sequence:

- Menu 6. Special functions - clock (see 12.1.)
- Menu 5. Settings, complete (see 10.)

Finally, menu 4.2 under operating mode “Manual“ should be used to test the switch outputs with the consumers connected, and to check the sensor values for plausibility. Then switch on automatic mode.



Caution

Observe the explanations for the the individual parameters on the following pages, and check whether further settings are necessary for your application.

6. Measurement values menu 1

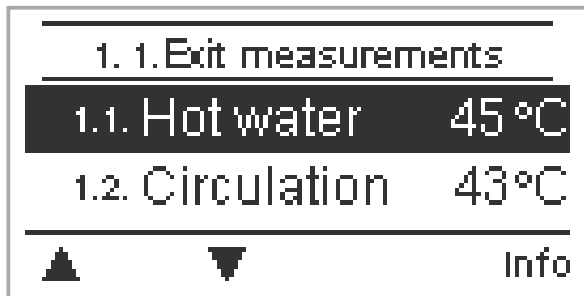

The menu “1. Measurement values” serves to display the currently measured temperatures.

The menu is closed by pressing “esc” or selecting “Exit measurement values”.

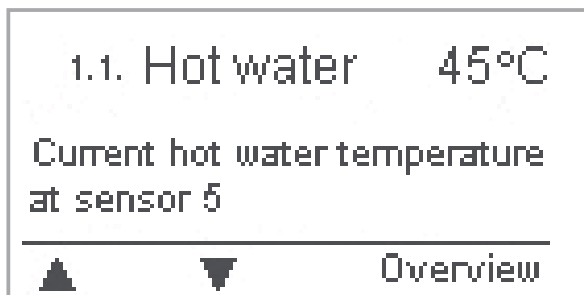

Selecting “Info” leads to a brief help text explaining the measurement values.

Selecting “Overview” or “esc” exits the Info mode.



Caution

If “Error” appears on the display instead of the measurement value, then there may be a defective or incorrect temperature sensor.

If the cables are too long or the sensors are not placed optimally, the result may be small deviations in the measurement values. In this case the display values can be compensated for by making entries on the controller. Follow the instructions under 12.3.

What measurement values are displayed depends on the selected program, the connected sensors and the specific device design.

7. Statistics



The menu “2. Statistics” is used for function control and long-term monitoring of the system.

The submenus described under 7.1-7.6 are available.



The menu is closed by pressing “esc” or selecting “Exit statistics”.



Caution For system data statistics it is essential for the time to be set accurately on the controller. Please note that the clock continues to run for about 24 hours if the mains voltage is interrupted, and after that has to be reset. Improper operation or an incorrect time may result in data being cleared, recorded incorrectly or overwritten. The manufacturer accepts no liability for the recorded data!

7.1 Operating hours HW (Menu 2.1)

Display of operating hours of the hot water pump connected to the controller.

7.2 Operating hours circ. (Menu 2.2)

Display of operating hours of the circulation pump connected to the controller.

7.3 Heat output (Menu 2.3)

Display of the heat output of the system in KWh



Resulting data is only approximate value for function control!

Caution

7.4 Graphic overview (Menu 2.4)

This provides a clearly-organised display of the data listed under 7.1-7.3 as a bar graph. Various time ranges are available for comparison. The two left-hand keys can be used to page through the data.

7.5 Error messages (Menü 2.5)

Display of the last three errors occurring in the system with indication of date and time.

7.6 Reset / clear (Menü 2.6)

Resetting and deleting the individual analyses. The function “All statistics” clears all analyses but not the error messages.

8. Display mode

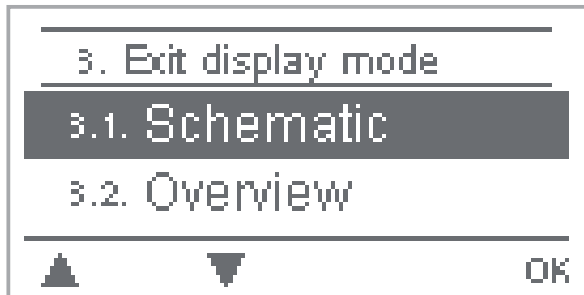

Menu “3. Display mode” is used to define the controller’s display for normal operation. This display appears whenever two minutes go by without any key being pressed. The main menu appears again when a key is pressed.

The menu is closed by pressing “esc” or selecting “Exit display mode”.

8.1 Schematic (Menu 3.1)

In graphics mode, the selected hydraulic systems are depicted with the measured temperatures and operating states of the connected consumers.

8.2 Overview (Menu 3.2)

In overview mode, the measured temperatures and operating states of the connected consumers are depicted in text form.

8.3 Alternating (Menu 3.3)

In alternating mode the schematic mode and then the overview mode are active for 5 seconds at a time.

9. Operating mode



In menu “4. Operating modes” the controller can either be placed in automatic mode, switched off, or placed in a manual operating mode.



The menu is closed by pressing “esc” or selecting “Exit operating modes”.

9.1 Automatic (Menu 4.1)



Caution

Automatic mode is the normal operating mode of the controller. Only automatic mode provides proper controller function taking into account the current temperatures and the parameters that have been set! After an interruption of the mains voltage the controller automatically returns to the last operating mode selected!

9.2 Manual (Menu 4.2)



Danger

When operating mode “Manual” is activated, the current temperatures and the selected parameters are no longer considered. There is a danger of scalding or serious damage to the system. The operating mode “Manual” may only be used by specialists for brief function tests or during commissioning! The relay and thus the connected consumer are switched on and off by pressing a key, with no regard to the current temperatures and the parameters which have been set. The measured temperatures are also shown to provide an overview and function control.

9.3 Off (Menu 4.3)



Caution

When the operating mode “Off” is activated, all controller functions are switched off. This can lead, for example, to overheating on the solar collector or other system components. The measured temperatures are still displayed to provide an overview.

10. Settings



The necessary basic settings required for the control function are made in menu “5. Settings”.



Caution

This does not under any circumstances replace the safety facilities to be provided by the customer!

The menu is closed by pressing “esc” or selecting “Exit settings”.



10.1 Tsetpoint (Menu 5.1) = Setpoint at sensor 5

The controller FWC3 attempts to maintain a constant temperature at sensor 5 by controlling the speed of the hot water pump.

Settings range: 30° C to 70° C / Default: 45° C

10.2 Tmax (Menu 5.2) = Maximum temperature at sensor 5

Maximum allowable temperature at sensor 5. If Tmax is exceeded, the pump is switched off. If the temperature drops below Tmax the pump is switched on again.

Settings range: 50° C to 75° C / Default: 60° C



Danger

Temperature values which are set too high can lead to scalding or damage to the system. Scalding protection must be provided by the customer!

10.3 VFS -Type (Menu 5.3) = Set the type of Vortex Flow Sensors

In this menu the type of Vortex Flow Sensor can be set.

Settings range: 1-20l/min, 2-40l/min, 5-100l/min, 10-200l/min, 20-400l/min

Default: 2-40l/min

10. Settings (Menu 5. continued)

10.4 Circulation (Menu 5.4 = Mode of circulation)

Set the mode of circulation in this menu.

In mode “**Off**” a circulation pump is not part of the design (see 2.5 Fig.1).

When the mode “**Request**” is active, the circulation pump is switched on after a corresponding withdrawal of water has occurred (see 10.5 to 10.8 for instructions to the necessary settings).

In mode “**Periods**” the circulation pump is enabled in the set periods (see 10.5 to 10.9 for instructions to the necessary settings)

Settings range: Off, Request, Periods / Default: Request



When mode “Periods” or “Request” is active, additional menu items are available in the “Settings” menu.

Caution

10.5 Circ. purging time (Menu 5.5) = Operating time of the circulation pump

The circulation pump is switched off after this period of time even if the set temperature is not reached at sensor 2. This is to prevent the pump from unnecessary running, e.g. when the storage buffer is too cold.

Settings range: 1 Min. to 20 Min. / Default: 2 Min.

10.6 Circ. pause time (Menu 5.6) = Circulation pump pause time

To prevent the pump from frequently switching on and off, this sets the minimum time the pump is not switched on again after being switched off.

Settings range: 1 Min. to 20 Min. / Default: 10 Min.



The menu items 10.5 to 10.7 are only available while the mode “Request” is active.

Caution

10. Settings (Menu 5. continued)

10.7 Circ.Tmin. (Menu 5.7) = Minimum temperature at sensor S2

If the temperature drops below Circ.Tmin at sensor 2 and the circulation is enabled (see 10.9), the circulation pump is started.

Settings range: 10° C to 55° C / Default : 30° C

10.8 Circ. hysteresis (Menu 5.8) = Switch-off hysteresis of the circulation pump

If the temperature exceeds TminS2 by this value (see 10.8), the circulation pump is switched off.

Settings range: 1K to 20K / Default: 5K

10.9 Circ. maximum Flow rate (Menu 5.9) = Maximum flow rate for the circulation pump

If the flow rate measured at sensor 6 exceeds this value (because water is being drained from the system) the circulation pump is switched off.

Settings range: 1 l/min to 50 l/min / Default: 5 l/min

10.10 Circulation period (Menu 5.10) = Period where the circulation pump is enabled

Set the operation times of the circulation pump. 3 different periods can be set for every weekday, which can also be copied to other days.

Settings range: Off/00:00 to 23:59 h/Default: 06:00-20:00 h



Caution

The menu item 10.10 is only available while the mode "Periods" is active.



Caution

*In periods not defined circulation is inactive.
The set periods are only used in the circulation mode "Periods".*



Caution

If the hot water flow exceeds the value defined in menu 10.9, the circulation pump is disabled.

11. Special functions



Menu “6. Special functions” is used to set basic items and expanded functions.



Caution

Other than the time all settings may only be made by a specialist.

The menu is closed by pressing “esc” or selecting “Exit special functions”.



11.1 Time & Date (Menu 6.1)

This menu is used to set the current time and date.



Caution

For proper functioning of the controller and statistics for the system data it is essential for the time to be set accurately on the controller.

Please note that the clock continues to run for about 24 hours if the mains voltage is interrupted, and after that has to be reset.

11.2 Sensor calibration (Menu 6.2 / 6.2.1 - 6.2.4)

Deviations in the temperature values displayed, for example due to cables which are too long or sensors which are not positioned optimally, can be compensated for manually here. The settings can be made for each individual sensor in steps of 0.5°C.

Offset S1...S3 per setting range: -10° C...+10° C Default: 0° C



Caution

Settings are only necessary in special cases at the time of initial commissioning by the specialist. Incorrect measurement values can lead to unpredictable errors.

11.3 Commissioning (Menu 6.3)

Starting the commissioning help guides you in the correct order through the basic settings necessary for commissioning, and provides brief descriptions of each parameter in the display. Pressing the “esc” key takes you back to the previous value so you can look at the selected setting again or adjust it if desired. Pressing the “esc” more than once takes you back to the selection mode, thus cancelling the commissioning help. (see also 5.1)



Caution

May only be started by a specialist during commissioning! Observe the explanations for the individual parameters in these instructions, and check whether further settings are necessary for your application.

11.4 Factory settings (Menu 6.4)

All of the settings that have been made can be reset, thus returning the controller to its delivery state.



Caution

The entire parametrisation, analyses, etc. of the controller will be lost irrevocably. The controller must then be commissioned once again.

11.5 Antilegionella menu 6.5 / 6.5.1 - 6.5.3

With the AL-function activated, the FWC3 3 makes it possible to heat the storage in selectable intervals, (AL interval) for the set residence time (AL resid. time), starting at the set time (AL start time) until the temperature AL Tset is reached. The temperature measured at S5 has a reference of AL Tset +5°. For the time the AL function is active, Tmax is set to AL Tset +10° to prevent system shutdown due to high temperature.

Only when a temperature of at least „AL Tset“ is reached at the circulation sensor for the time set in „Al resid. time“, the AL function is regarded as successful. This is displayed as “AL heat.”, menu 6.5.6. If AL is unsuccessful after 2 hours, the attempt is canceled and will be started again the next day and an error message is displayed.

AL Function - Settings range: On or Off/ Default: Off

AL start time- Settings range 00:00 to 23:59 Uhr / Default 04:00 h

AL Tset - Settings range: 60°C to 99°C / Default: 70°C

AL Interval - Settings range: 3 to 28 days/ Default: 7 days

AL residence time - settings range: 1-60minutes / Default: 15 minutes



Danger!

During the anti-Legionella function the storage tank is heated up to high temperatures which can lead to scalding and damage to the system.



Caution

The user has to make sure that the antilegionella function was successful at the set intervals.



Caution

The AL function is switched off by default.

A message also containing the date is shown as soon as the AL function was completed successful. We recommend to set the „AL start time“ in a period where little or no withdrawal of water takes place.



Caution

The user has to make sure that the storage temperature is AL Tset +5° when starting AL. When the storage sensor S3 is installed: If AL Tset+5° is not reached, the AL function is not started.



Caution

This anti-Legionella function does not provide complete protection against Legionella, because the controller is dependent on sufficient energy being fed in.

11.6 Expansions menu 6.6

This menu can only be selected and used if additional options or expansions have been built into the controller. The associated supplementary installation, mounting and operation instructions are then included with the specific expansion.

11.7 Speed control (Menu 6.7)

If the speed control is activated, the FWC3 makes it possible to vary the speed of standard pumps at relay R1 by means of special internal electronics.



Caution

This should only be activated and set up by a specialist! Wrong settings can damage the system! Refer to the pump and system manufacturer's manuals. If unsure, it is better to set the min. speed and pump level higher than lower.

11.7.1 Max. speed (Menu 6.7.1)

The maximum speed of the pump at relay R1 is specified here. During the setting the pump runs at the specified speed and the flow rate can be determined.

Setting range: 70 to 100% / Default: 100%



Caution

The real percentage may vary due to differences in the system, pump etc.

11.7.2 Min. speed (Menu 6.7.2)

The minimum speed of the pump at relay R1 is specified here. During the setting the pump runs at the specified speed and the flow rate can be determined.

Settings range: 15 to max. speed -5% / Default: 17%



Caution

The real percentage may vary due to differences in the system, pump etc.

11.8 Lime scale protection (Menu 6.8)

To prevent heat accumulation and resulting lime scale residue in the heat exchanger, the circulation pump can keep on running for a few seconds after water has been drained.

Settings range: On / Off / Default: Off

12. Menu lock (Menu 7.)



Menu “7. Menu lock” can be used to secure the controller against unintentional changing of the set values.

The menu is closed by pressing “esc” or selecting “Exit menu lock”.

The menus listed below remain completely accessible despite the menu lock being activated, and can be used to make adjustments if necessary:

1. Measurement values
2. Analysis
3. Display mode
8. Menu lock
9. Service values

To lock the other menus, select “Menu lock on”.

To enable the menus again, select “Menu lock off”.

Setting range: on, off/default setting: off

13. Language



Menu “9. Language” can be used to select the language for the menu guidance. This is queried automatically during initial commissioning. The choice of languages may differ, however, depending on the device design. Language selection is not available in every device design!

14. Service values (Menu 8.)

8.2. Hot water	45 °C
8.3. Circulation	43 °C
8.4. Cold water	12 °C



The menu “8. Service values” can be used for remote diagnosis by a specialist or the manufacturer in the event of an error, etc.



Caution Enter the values at the time when the error occurs e.g. in the table.

The menu can be closed at any time by pressing “esc”.

8.1.	
8.2.	
8.3.	
8.4.	
8.5.	
8.6.	
8.7.	
8.8.	
8.9.	
8.10.	
8.11.	
8.12.	
8.13.	
8.14.	
8.15.	
8.16.	
8.17.	
8.18.	
8.19.	
8.20.	
8.21.	
8.22.	
8.23.	
8.24.	
8.25.	
8.26.	
8.27.	
8.28.	
8.29.	
8.30.	

8.31.	
8.32.	
8.33.	
8.34.	
8.35.	
8.36.	
8.37.	
8.38.	
8.39.	
8.40.	
8.41.	
8.42.	
8.43.	
8.44.	
8.45.	
8.46.	
8.47.	
8.48.	
8.49.	
8.50.	
8.51.	
8.52.	
8.53.	
8.54.	
8.55.	
8.56.	
8.57.	
8.58.	
8.59.	
8.60.	

15.1 Malfunctions with error messages

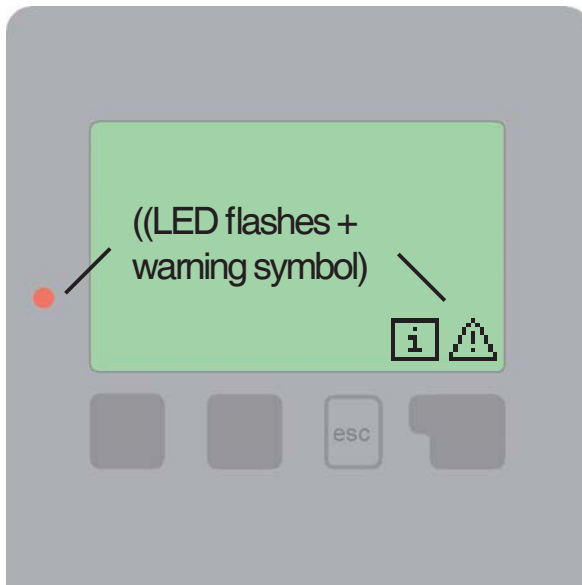

If the controller detects a malfunction, the red light flashes and the warning symbol also appears in the display. If the error is no longer present, the warning symbol changes to an info symbol and the red light no longer flashes. To obtain more detailed information on the error, press the key under the warning or info symbol.



Do not try to deal with this yourself. Consult a specialist in the event of an error!

Possible error messages:

Notes for the specialist:

Sensor x defective ----->

Means that either the sensor, the sensor input at the controller or the connecting cable is/was defective. (Resistance table on page 5)

Time&date ----->

This display appears automatically after a mains failure because the time&date have to be checked, and reset if necessary.

Temperature < 50

The temperature at the optional sensor S4 fell below 50 °C. This means that the primary temperature is too low, so it could be possible to produce not enough hot water

Temperature > 70

The temperature at the optional sensor S4 exceeded 70 °C. This means that the primary temperature is too high, so it is possible to have limescale in the exchanger

16.2 Replacing the fuse



Danger

Repairs and maintenance may only be performed by a specialist. Before working on the unit, switch off the power supply and secure it against being switched on again! Check for the absence of power!



Danger

Only use the supplied spare fuse or a fuse of the same design with the following specifications: T2A 250V

Fig.3.1.1

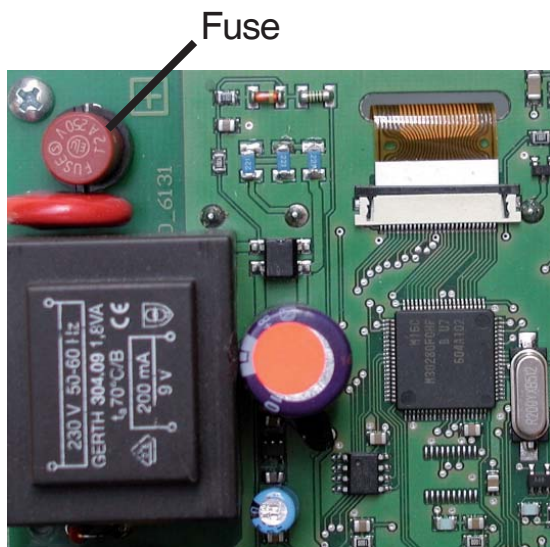

If the mains voltage is switched on and the controller still does not function or display anything, then the internal device fuse may be defective. In that case, open the device as described under 3.1, remove the old fuse and check it.

Exchange the defective fuse for a new one, locate the external source of the error (e.g. pump) and exchange it. Then first recommission the controller and check the function of the switch outputs in manual mode as described under 9.2.

16.3. Maintenance



Caution In the course of the general annual maintenance of your heating system you should also have the functions of the controller checked by a specialist and have the settings optimised if necessary.

Performing maintenance:

- Check the date and time (see 11.1)
- Assess/check plausibility of analyses (see 7.)
- Check the error memory (see 7.5)
- Verify/check plausibility of the current measurement values (see 6.)
- Check the switch outputs/consumers in manual mode (see 9.2)
- Poss. optimise the parameter settings

Notes

Notes

Notes

Hydraulic variant set:

Commissioned on:

Commissioned by:

Notes:

Final declaration:

Although these instructions have been created with the greatest possible care, the possibility of incorrect or incomplete information cannot be excluded. Subject as a basic principle to errors and technical changes.
